

Simatic variable types

Bit & Byte

The **Bit** is the simplest form; it's a signal that can be true or false, with its official English equivalents being "TRUE" or "FALSE," or even simply 0 or 1. There is no 2 anymore because two is represented by 10 according to the rules of the binary number system, which in this case is not ten but one zero. To clearly distinguish this, we write numbers in the decimal number system "just like that," for example, 10. If this is a number in the binary number system, then we denote it as **2#10**.



The decimal number system stems from the fact that we have ten fingers and, historically, used them to perform all our calculations. If we had, say, three fingers on each hand, meaning six in total, then we would be using the six-number system now. Computing is based on the above yes-or-no logic, i.e., the binary number system, which is why we often use the hexadecimal number system. I'll talk about that later. Let's first look at the binary number system through a byte to see how it works.

A byte is a variable type consisting of 8 bits. The value stored in it must be somewhere between 0 and 255, depending on the bit positions. The example below may help you understand this a little:

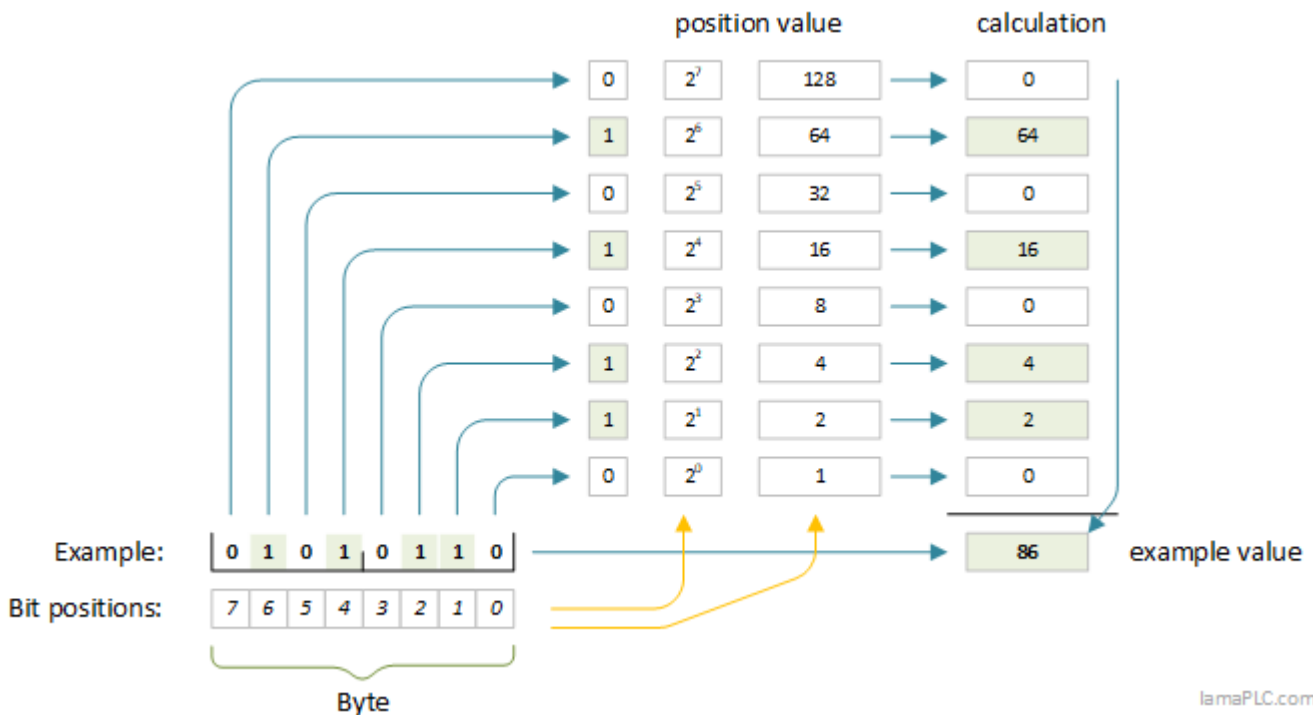

Let's take the bit sequence "01010110" as an example, which fills the above byte. The bits of a byte are always numbered from right to left; position 0 is always on the right. Each position corresponds to a given power of the binary number system; position 4 corresponds to $2^4 = 16$. If there is a 0 in this position in the example, then it does not "count"; if there is a one, then its value "counts", and as can be seen in the rows marked in green, the sum of the "counting" rows gives the current decimal value of the byte, 86. That is, **2#01010110 = 86**.

Therefore, the byte reaches its maximum value when all bits are set to 1. It can be calculated that **2#11111111 = 255**. The byte data type holds values between 0 and 255.

In computing, we use the base-10 number system, as well as the binary and base-16 number systems. The values described in it are called hexadecimal numbers and are denoted by the prefix "16#" or sometimes "hex#". Sometimes the hexadecimal number system is simply the hash, like this: "#ABCD". The hexadecimal number system changes order of magnitude at 16, meaning that a position can contain a value between 0 and 15. This can be very confusing in the base 10 number system, so the two-digit positions are denoted by letters:

- 10 = 16#A
- 11 = 16#B
- 12 = 16#C
- 13 = 16#D
- 14 = 16#E
- 15 = 16#F

If a byte reaches its maximum value, meaning every bit is set to "1", then: **2#11111111 = 255 = 16#FF**

If we calculate: F, i.e., "15" * 16 + "15" = 255

In some ways, this can make our lives easier, because if we see a value of "16#FF" somewhere, or a longer series of these, for example "16#FFFF_FFFF", then we can suspect that we have reached the maximum value of one of the variable types. I would also like to mention the 8-bit, i.e., octal number system, it sometimes still occurs here and there, for example, in the case of numerical symbols, but only rarely, we don't really use it.

DEAD_BEEF

Just as "FF" is likely to represent the maximum of a given variable type, dead beef is a test value designation, a play on letters. The letters of the hexadecimal number system are a, b, c, d, e, f. #dead_beef contains all of them except c, so it is helpful for testing. The Windows calculator, switched to programmer mode, is very helpful for hex-dec-bin conversions. From this, it turns out that the value of **16#dead_beef** is:

DEAD BEEF

HEX	DEAD BEEF
DEC	3.735.928.559
OCT	33 653 337 357
BIN	1101 1110 1010 1101 1011 1110 1110 1111

2026/04/23 21:51



More information: TIA Datatypes: [S7 data types summary table](#)

2026/04/23 21:51

BYTE - WORD type variables

There are plenty of variables in the world of automation. They differ in scope (size) and internal structure depending on their use.

The simplest variable types have no internal structure, i.e., they can describe ones and zeros in different scopes:

D	E	A	D	B	E	E	F	Example in hexadecimal
1 1 0 1		1 1 1 0		1 0 1 0		1 1 0 1		Example in binary
						7 6 5 4 3 2 1 0		Byte (8 bit)
				15 14 13 12 11 10 9 8		7 6 5 4 3 2 1 0		Word (16 bit)
31 30 29 28 27 26 25 24		23 22 21 20 19 18 17 16		15 14 13 12 11 10 9 8		7 6 5 4 3 2 1 0		DWord (32 bit)
3. byte		2. byte		1. byte		0. byte		Byte positions

The longest 64-bit LWord didn't fit in the example above, but I think it's relatively easy to imagine. The byte positions are on the bottom row. If everything works well, this is the byte order for the longer variable types, but sometimes confusion arises in the matrix, and this order gets "tangled".

This most often happens when we try to transfer long variables via communication to other systems, such as HMI. In such cases, it is definitely worth testing the transfer, for example, with the above trick, because when the specified #deadbeef is on one side. If the destination side shows #beefdead or #efbeadde, we can rightly suspect a conversion discrepancy, which is easiest to correct on the starting side by swapping the structures.

The following types are unsigned (UNSIGNED), meaning their minimum value is always zero.

Let's review the basic variable types and their features:

Type	Bit	Min.	Max.	Value range HEX	Value range DEC
BYTE	8	0	2 ⁸ -1	0 .. FF	0 .. 255
WORD	16	0	2 ¹⁶ -1	0 .. FFFF	0 .. 65.535
DWORD	32	0	2 ³² -1	0 .. FFFF_FFFF	0 .. 4.294.967.295
LWORD	64	0	2 ⁶⁴ -1	0 .. FFFF_FFFF_FFFF_FFFF	0 .. 18.446.744.073.709.551.615

Any rules do not bind the contents of the above variables; they actually only contain some bit combinations. They can't have negative values by default; INT type variables are used for that.



 More information: TIA Datatypes: [S7 data types summary table](#)

2026/04/23 21:51

INT type variables

In the case of the INT, which is the integer type, the definition becomes slightly more complex in terms of formal constraints because of the introduction of the sign bit. This means that the highest-order bit of the variable's position, the first bit on the left, represents the sign: if it is "1", the variable indicates a negative number, whereas if it is "0", it indicates a positive one.

 Really, just for completeness, in the case of negative numbers, the program uses the so-called "two's complement" representation. That is, it first negates all the bits of the numerical value, i.e., it converts 0 to 1 and vice versa, and then adds 1 to the resulting value. This conversion means that the negative value cannot be read directly from the bit combination unless the conversion is performed again in the opposite direction:

Two's complement method by INT type

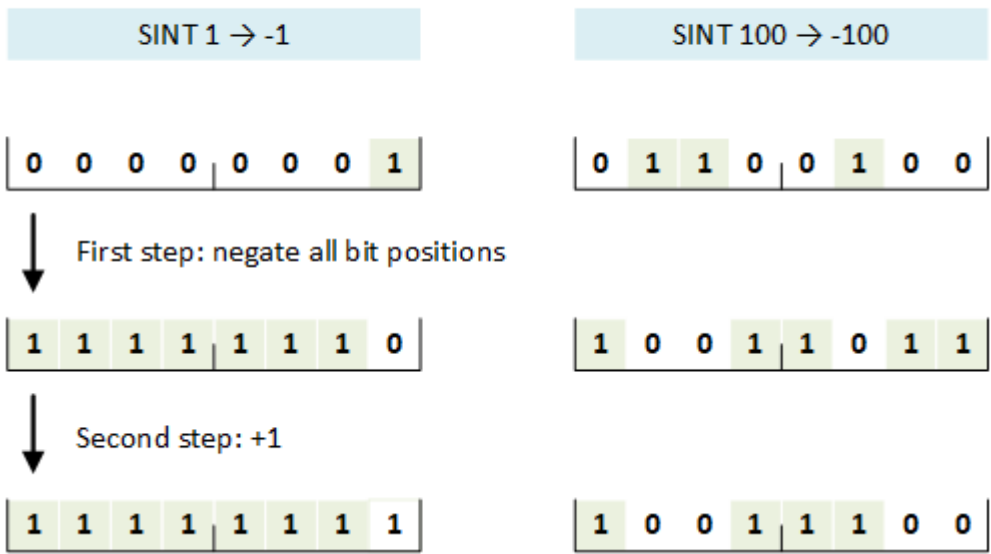

As a result, Simatic only uses binary and hexadecimal notations for positive numbers, meaning that negative hexadecimal or binary values will not show the actual numerical value but instead the value based on the bit pattern. For example, A, which equals ten, will still be 16#A, but -A, which equals -10, will be displayed in WORD format as FFF6. This misunderstanding is resolved by the rule that hexadecimal and binary signals cannot have negative values in Simatic:

```

1
2 #intValue := 128;
3
4 #intValue := -128;
5
6 #intValue := 16#AA;
7
8 #intValue := 16#-AA;
9
10 #intValue := 2#00011111;
11
12 #intValue := 2#-00011111;

```

In the above example, I tried to assign a value to an INT variable. It is clear that the compiler accepted the negative value when specified in decimal, but not when specified in hexadecimal or binary. Let's look at the contents of the INT variable in several forms:

DEC	SINT HEX (8-bit)	SINT BIN (8-bit)	INT HEX (16-bit)	INT BIN (16-bit)
12	16#7F	2#0111_1111	16#007F	2#0000_0000_0111_1111
1	16#01	2#0000_0001	16#0001	2#0000_0000_0000_0001
-1	16#FF	2#1111_1111	16#FFFF	2#1111_1111_1111_1111
-85	16#AB	2#1010_1011	16#FFAB	2#1111_1111_1010_1011
-128	16#80	2#1000_0000	16#FF80	2#1111_1111_1000_0000



The INT type is optimized for decimal handling; it can also be used in hexadecimal and binary forms, but in these cases, you need to pay close attention to the type's special characteristics.

Compared to byte and word type variables, this means that the maximum value of these variables is almost halved when dealing with decimal numbers. However, roughly the same magnitude can be used in the negative direction. For example, a one-byte-long SINT type will operate within the range -128 to 127, unlike the "plain" BYTE range of 0 to 255.

The letter "S" in the SINT definition stands for the word "short", as the INT type is the default integer (16 bits), while SINT is short, with half the bit length—8 bits. The letter "D" represents the word "double," with its 32 bits.

Type	Name	Bit	Minimum	Maximum	Value range HEX *	Value range DEC
SINT	short integer	8	$-(2^7)$	2^7-1	0 .. 7F	-128 .. 127
INT	integer	16	$-(2^{15})$	$2^{15}-1$	0 .. 7FFF	-32.768 .. 32.767
DINT	double integer	32	$-(2^{31})$	$2^{31}-1$	0 .. 7FFF_FFFF	-2.147.483.648 .. +2.147.483.647
LINT	double long integer	64	$-(2^{63})$	$2^{63}-1$	0 .. 7FFF_FFFF_FFFF_FFFF	-9.223.372.036.854.775.808 .. +9.223.372.036.854.775.807

* Negative number ranges are not supported in hexadecimal and binary formats.

UINT type variables

The unsigned UINT type (the letter **U** stands for unsigned) removes the hassle of dealing with negative values from the world of the INT type. It corresponds to basic types like BYTE, WORD, etc., in terms of value range, but with INT it indicates that we want to treat the contents of the variables as numeric values.

Type	Name	Bit	Minimum	Maximum	Value range HEX *	Value range DEC
USINT	unsigned short integer	8	0	2 ⁸	0 .. FF	0 .. 255
UINT	unsigned integer	16	0	2 ¹⁶	0 .. FFFF	0 .. 65.535
UDINT	Unsigned double integer	32	0	2 ³²	0 .. FFFF_FFFF	0 .. 4.294.967.295
ULINT	Unsigned long integer	64	0	2 ⁶⁴	0 .. FFFF_FFFF_FFFF_FFFF	0 .. 18.446.744.073.709.551.615

* Negative number ranges are not supported in hexadecimal and binary formats.



More information: TIA Datatypes: [S7 data types summary table](#)

2026/03/09 14:09

REAL type variables

REAL type variables (**REAL**, **LREAL**, or **floating-point numbers**) are defined by the **IEEE 754** (*IEEE 754/1985 Floating Point Number Format*) standard. This is a fairly complex type that, despite its intimidating complexity, is well-suited for storing fractional numbers.

If you are interested in the definition of the type, please look it up on Wikipedia, for example, because I can't; I can't explain how this type works simply.

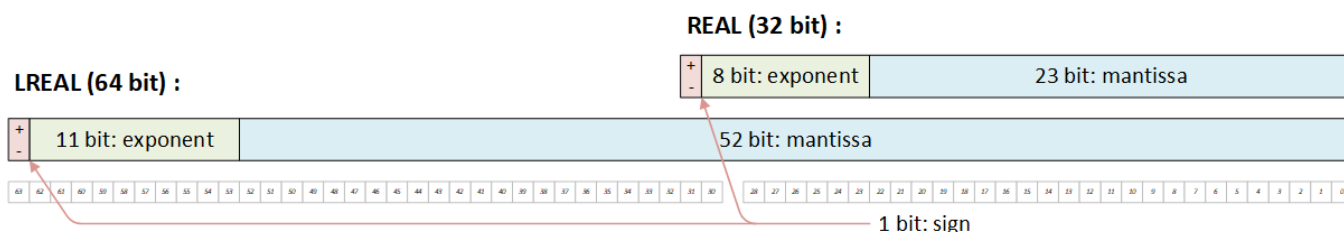

- **Sign:** The sign is determined by one bit (red color). This bit can be either "0" (positive) or "1" (negative).
- **Exponent:** The exponent ranges from 128 to -127.
- **Mantissa:** Only the mantissa is a fractional part of the overall value.

Type	Bit	Byte	Value range DEC
REAL	32	4	-3.402823e+38 .. -1.175 495e-38 .. +1.175 495e-38 .. +3.402823e+38

Type	Bit	Byte	Value range DEC
LREAL	64	8	-1.7976931348623158e+308 .. -2.2250738585072014e-308 .. +2.2250738585072014e-308 .. +1.7976931348623158e+308

In practice, REAL is suitable for handling fractions and large values. Due to its nature, it is mainly used for processing and evaluating measurements. It is important to note that, because of its structure, if a very large value is stored in it and we try to increase or decrease it by, say, a very small value, nothing will happen; the stored value will not change. The type is inherently not suitable for handling exact counters, since it handles numbers “in order of magnitude.” [INT](#) is more appropriate for counting functions.



More information: TIA Datatypes: [S7 data types summary table](#)

2026/04/23 21:51



If you'd like to support the development of the site with the price of a coffee — or a few — [please do so here](#).

2026/01/06 16:16

CHAR type variables

CHAR (*character*) types are suitable for storing a single letter each. The original CHAR uses codes from the ancient **ASCII** character mapping table. This table contains a mix of 255 different characters (letters, numbers, control characters, graphic symbols). Its advantage is that it requires only 1 byte, but its disadvantage is that the character set is quite limited; for example, Hungarian or Chinese accented characters are mostly excluded.

The extended version of CHAR is **WCHAR** (wide-character), which has a 2-byte length but can be used more broadly with its (**UNICODE**) UCS-2 mapping. Up to 65,535 character mappings can be encoded with 16 bits; UNICODE does not fully utilize this range.

When declaring an operand of data type WSTRING you can define its length using square brackets (for example WSTRING[10]). If you do not specify a length, the length of the WSTRING is set to 254 characters by default.

Type	Name	Bit	Code table	Value range HEX	Value range DEC	Example
CHAR	character	8	ASCII	0 .. FF	0 .. 255	'P', CHAR#'P'
WCHAR	Wide character	16	UCS-2	\$0000 - \$D7FF	0 .. 55.295	WCHAR#'Ó'

Special characters

A character string can also contain special characters. The escape character \$ is used to identify control characters, dollar signs and single quotation marks.

Character	Hex	Meaning	Example
\$L or \$I	000A	Line feed	'\$LText', '\$000AText'
\$N	000A and 000D	Line break The line break occupies 2 characters in the character string.	'\$NText', '\$000A\$000DText'
\$P or \$p	000C	Page feed	'\$PText', '\$000CText'
\$R or \$r	000D	Carriage return (CR)	'\$RText', '\$000DText'
\$T or \$t	0009	Tab	'\$TText', '\$0009Text'
\$	0024	Dollar sign	'100\$t', '100\$0024t'
\$'	0027	Single quotation mark	'\$'Text\$', '\$0027Text\$0027'

2026/04/23 21:51

STRING type variables

STRING also has two subtypes, just like **CHAR**. The old, "old-school" **STRING**, which describes the text with ASCII characters, and **WSTRING**, which uses **WCHAR** characters with two bytes per character. Both types are suitable for storing text, which can be extremely useful for communication, especially in HMI connections.

For both types, the first two positions show the maximum length of the given **STRING** and the current length it has been filled with. One position equals one byte for **STRING**, and one word for **WSTRING**.

Name	Address	Display format	Monitor value
"example".tString	P#DB9.DBX0.0	String	'lama!'
	%DB9.DBB0	Hex	16#08
	%DB9.DBB1	Hex	16#05
"example".tString[1]	%DB9.DBB2	Character	'l'
"example".tString[2]	%DB9.DBB3	Character	'a'
"example".tString[3]	%DB9.DBB4	Character	'm'
"example".tString[4]	%DB9.DBB5	Character	'a'
"example".tString[5]	%DB9.DBB6	Character	'!'
"example".tString[6]	%DB9.DBB7	Character	'\$00'

In the example above, taken from the PLC status, I entered the phrase "lama!" into an 8-byte **STRING** variable. The first two bytes contain the maximum length of the **STRING** (8) and the current length (5), followed by the phrase as our message.

If I change the display format to hexadecimal for the characters, I see the ASCII code for each letter.

Name	Address	Display format	Monitor value
"example".tString	P#DB9.DBX0.0	String	'lama!'
	%DB9.DBB0	Hex	16#08
	%DB9.DBB1	Hex	16#05
"example".tString[1]	%DB9.DBB2	Hex	16#6C
"example".tString[2]	%DB9.DBB3	Hex	16#61
"example".tString[3]	%DB9.DBB4	Hex	16#6D
"example".tString[4]	%DB9.DBB5	Hex	16#61
"example".tString[5]	%DB9.DBB6	Hex	16#21
"example".tString[6]	%DB9.DBB7	Hex	16#00

That is, the letter "l" is ASCII 16#6C, and "a" is ASCII 16#61, ... For **WSTRING**, this assignment

appears like this:

Name	Address	Display format	Monitor value
"example".tString	P#DB9.DBX0.0	Unicode string	WSTRING#'lama!'
	%DB9.DBW0	Hex	16#0008
	%DB9.DBW2	Hex	16#0005
"example".tString[1]	%DB9.DBW4	Character	'\$00l'
"example".tString[2]	%DB9.DBW6	Character	'\$00a'
"example".tString[3]	%DB9.DBW8	Character	'\$00m'
"example".tString[4]	%DB9.DBW10	Character	'\$00a'
"example".tString[5]	%DB9.DBW12	Character	'\$00!'
"example".tString[6]	%DB9.DBW14	Character	'\$00\$00'

The "\$00l" content type is due to the nature of UNICODE, as "simple" characters do not fill the entire UCS-2 space. It is clear that while we counted the positions per byte above, in this case each position occupies a word. The first two words here also contain the maximum length of the STRING (8) and the current length (5).

The same definition is given in hexadecimal form as follows:

Name	Address	Display format	Monitor value
"example".tString	P#DB9.DBX0.0	Unicode string	WSTRING#'lama!'
	%DB9.DBW0	Hex	16#0008
	%DB9.DBW2	Hex	16#0005
"example".tString[1]	%DB9.DBW4	Hex	16#006C
"example".tString[2]	%DB9.DBW6	Hex	16#0061
"example".tString[3]	%DB9.DBW8	Hex	16#006D
"example".tString[4]	%DB9.DBW10	Hex	16#0061
"example".tString[5]	%DB9.DBW12	Hex	16#0021
"example".tString[6]	%DB9.DBW14	Hex	16#0000

If we fully fill in the UCS-2 word field, we can see what the "non-simple characters" look like. In the first step, I entered longer codes in the word variables per character (1), and from this the "example" WSTRING (2) was displayed:

Name	Address	Display format	Monitor value	Modify value
"example".tString	P#DB9.DBX0.0	Unicode string	WSTRING#'=<2:臉陶'	
	%DB9.DBW0	Hex	16#0008	
	%DB9.DBW2	Hex	16#0005	
"example".tString[1]	%DB9.DBW4	Hex	16#1111	16#1111
"example".tString[2]	%DB9.DBW6	Hex	16#2222	16#2222
"example".tString[3]	%DB9.DBW8	Hex	16#3333	16#3333
"example".tString[4]	%DB9.DBW10	Hex	16#4444	16#4444
"example".tString[5]	%DB9.DBW12	Hex	16#5555	16#5555

WSTRING#'=<2:臉陶'

To sum it all up:

Type	Length	Character encoding	Length (characters)	Example
------	--------	--------------------	---------------------	---------

Type	Length	Character encoding	Length (characters)	Example
STRING	2 byte + text	CHAR, ASCII	0 .. 254 byte / character	'lamaPLC', STRING#'lamaPLC'
WSTRING	2 word + text	WCHAR, UNICODE	0 .. 16382 word / character	WSTRING#lamaPLC



More information: TIA Datypes: [S7 data types summary table](#)

2026/04/23 21:51

TIME type variables

TIME types mainly serve for timing purposes. The most common type in programs is simple TIME, such as in connection with IEC timings, like this:

```

9  □ #Ttimer(IN:=#start,
10  [      PT:=t#12s);
11

```

#start	FALSE

These will be discussed later, but in the example above, the time (PT) is specified in TIME format, with 12 seconds written as **t#12s**.

TIME is a DINT type variable that stores time in 32 bits, measured in milliseconds. The stored value can be positive or negative, and the rules for negative integers apply, meaning negative TIME values cannot be represented in hexadecimal or binary form.

The same rules apply to the LTIME type, but it stores nanoseconds in an LINT variable, using 64 bits. Interestingly, the maximum value of LTIME is 106,751 days, or about 292 years.

The S5TIME type was included among the variables for downward compatibility; it was the default (and only) time type during the S5 PLC era.

Type	Length (form)	Value Range HEX	Value Range DEC	Example
TIME	32 bit (DINT)	0 .. 7FFF_FFFF	T#-24d20h31m23s648ms .. T#+24d20h31m23s647ms	T#12s, 16#ABCD
LTIME	64 bit (LINT)	0 .. 7FFF_FFFF_ FFFF_FFFF	LT#-106751d23h47m16s 854ms775us808ns .. LT#+106751d23h47m16s 854ms775us807ns LT#12s	LTIME#12s, 16#ABCD
S5TIME	16 bit		S5T#0H_0M_0S_0MS .. S5T#2H_46M_30S_0MS	S5T#10s, S5TIME#10s

S5TIME

- Underscores in time and date are optional
- It is not necessary to specify all time units (for example: T# 5h10s is valid)

- Maximum time value = 9,990 seconds or 2H_46M_30S

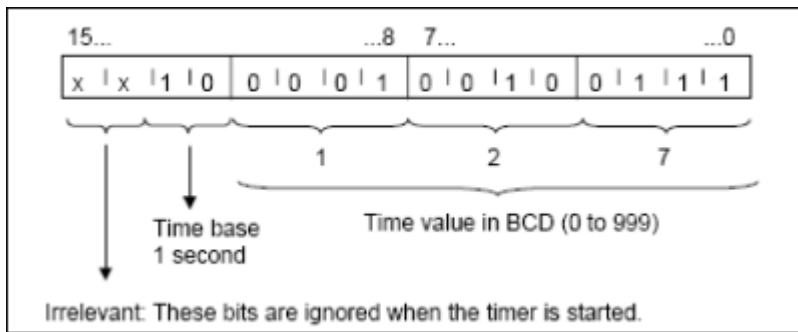

Time base	Binary Code
10 ms	00
100 ms	01
1 s	10
10 s	11

 More information:
TIA Datatypes: [S7 data types summary table](#)

2026/04/23 21:51

 If you'd like to support the development of the site with the price of a coffee — or a few — [please do so here](#).

2026/01/06 16:16

Array

An **array** is used to group data of the same type into blocks that can be easily addressed, i.e., indexed.

Arrays can be 1-, 2-, or 3-dimensional, or even 6-dimensional. The following example illustrates the structure of 2- and 3-dimensional arrays:

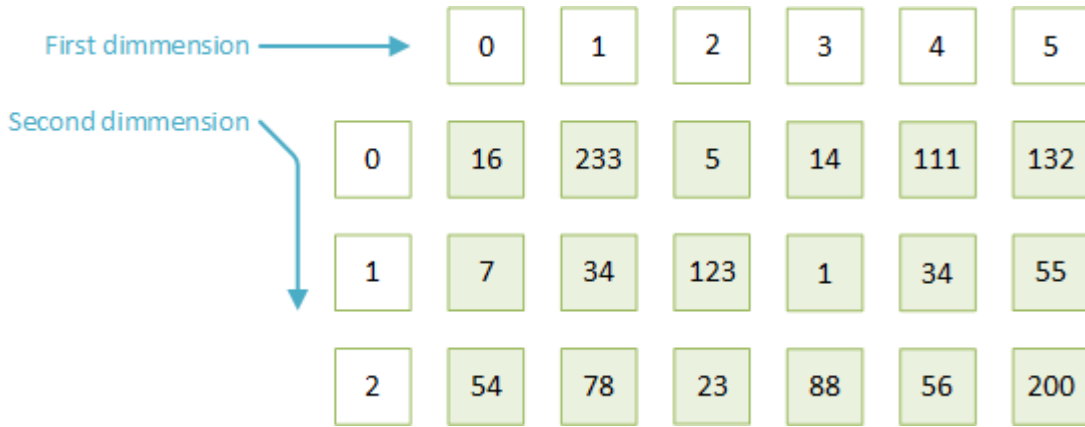

The image above displays a two-dimensional array of type "byte." The first index represents the rows, while the second represents the columns. The value range of a byte is 0 to 255, so only values within this range are allowed. In the example above, the program's type definition is as follows:

```
array : Array[0..5, 0..2] of Byte;
```

The assignment is displayed in the code like this:

```
tomb[3, 1] := 1;
```

The indexing of a three-dimensional array can be illustrated as follows:

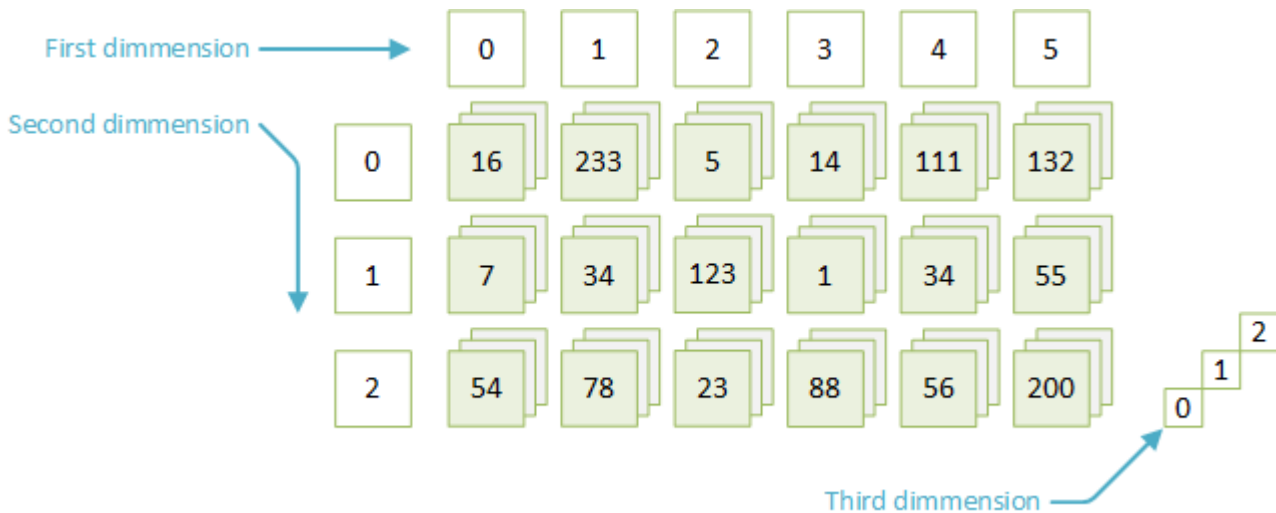

In this case, the above assignment can be defined in the program as follows:

```
tomb[3, 1, 0] := 1;
```

Array of struct

The elements of the array are always homogeneous, meaning their types cannot vary. However, there

can be multiple instances of a single type within a single array if we define a Struct type as an array element. The hydraulic motors described as an example in [Struct](#) can also be defined as an array:

motors					
Name	Data type	Start value	Monitor value	Comment	
▾ tomb	Array[0..4] of Struct				
▾ tomb[0]	Struct				
motorid	String	'1 4LAC01'		1 4LAC01 Hydraulicpumpe	
voltage	Real	402.0		1 4LAC01 CE001 (V)	
current	Real	5.2		1 4LAC01 CE002 (A)	
mode	Byte	3		1 4LAC01 CE003 (On, Off, Auto)	
status	Byte	1		1 4LAC01 CE004 (Run, Stop, Error)	
local	Byte	1		1 4LAC01 CE005 (remote, local)	
▾ tomb[1]	Struct				
motorid	String	"		1 4LAC01 Hydraulicpumpe	
voltage	Real	0.0		1 4LAC01 CE001 (V)	
current	Real	0.0		1 4LAC01 CE002 (A)	
mode	Byte	16#0		1 4LAC01 CE003 (On, Off, Auto)	
status	Byte	16#0		1 4LAC01 CE004 (Run, Stop, Error)	
local	Byte	16#0		1 4LAC01 CE005 (remote, local)	
▾ tomb[2]	Struct				
▾ tomb[3]	Struct				
▾ tomb[4]	Struct				

In this case, I specified the type of the four-element array as "Struct". Here, a field opens under the name of the first array element (tomb[0]), where the Struct's elements can be defined. It is important that the array is homogeneous, meaning the structure can only be set for the first element; the other elements will be copies of it without the ability to modify the structure (values, of course, can change). In the example above, the value assignment will look like this (the DB name is "motors"):

```
"motors".tomb[1].current := 32.2;
```



More information:
TIA Datatypes: [S7 data types summary table](#)

2026/04/23 21:51

Structure

A structure is a way of organizing multiple variables, often of different types, into a group. For example, the characteristics of several devices, such as motors, can be described using the same data groups.

Take an electric motor, for instance. Such a motor can have many technical parameters, but for simplicity, let's narrow down the range of these parameters.

„motorId“ : string
„voltage“ : real
„current“ : real
„mode“ : byte
„status“ : byte
„local“ : byte

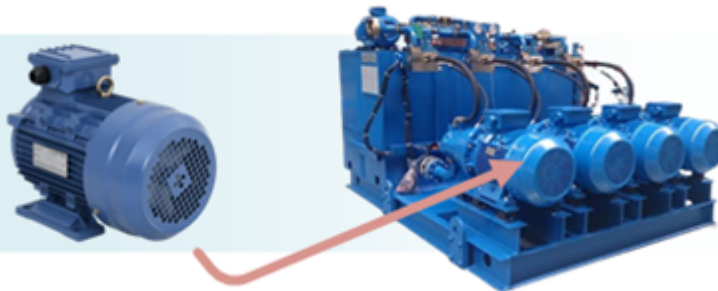

In this case, the motor has a text identifier, typically a KKS identifier in larger installations. Then there are voltage and current measurements, an operating mode, and a status indication. These data belong together and describe a motor. In the example above, this motor is, for example, the first motor of a hydraulic block. In the case of multiple motors, this structure remains—only the parameters change, as this makes it easy to handle the data uniformly:

„hydraulicmotor_1“ : struct	„hydraulicmotor_2“	„hydraulicmotor_3“	„hydraulicmotor_4“
„motorId“ : string			
„voltage“ : real			
„current“ : real			
„mode“ : byte			
„status“ : byte			
„local“ : byte			

This is what it looks like in the TIA Portal when the structures are open:

motors					
Name	Data type	Start value	Monitor value	Comment	
▼ Static					
▼ hydraulicMotor_1	Struct				
motorId	String	'1 4LAC01'	'1 4LAC01'	1 4LAC01 Hydraulicpumpe	
voltage	Real	402.0	402.0	1 4LAC01 CE001 (V)	
current	Real	5.2	5.2	1 4LAC01 CE002 (A)	
mode	Byte	3	16#03	1 4LAC01 CE003 (On, Off, Auto)	
status	Byte	1	16#01	1 4LAC01 CE004 (Run, Stop, Error)	
local	Byte	1	16#01	1 4LAC01 CE005 (remote, local)	
▼ hydraulicMotor_2	Struct				
motorId	String	'1 4LAC02'	'1 4LAC02'	1 4LAC02 Hydraulicpumpe	
voltage	Real	400.3	400.3	1 4LAC02 CE001 (V)	
current	Real	0.0	0.0	1 4LAC02 CE002 (A)	
mode	Byte	3	16#03	1 4LAC02 CE003 (On, Off, Auto)	
status	Byte	2	16#02	1 4LAC02 CE004 (Run, Stop, Error)	
local	Byte	1	16#01	1 4LAC02 CE005 (remote, local)	
▼ hydraulicMotor_3	Struct				
motorId	String	'1 4LAC03'	'1 4LAC03'	1 4LAC03 Hydraulicpumpe	
voltage	Real	402.0	402.0	1 4LAC03 CE001 (V)	
current	Real	0.0	0.0	1 4LAC03 CE002 (A)	

The display of structures can be limited to just their names, with an arrow placed in front of the name to close the content:

motors					
Name	Data type	Start value	Monitor value	Comment	
▼ Static					
▶ hydraulicMotor_1	Struct				
▶ hydraulicMotor_2	Struct				
▶ hydraulicMotor_3	Struct				
▶ hydraulicMotor_4	Struct				





More information:

TIA Datatypes: [S7 data types summary table](#)

2026/04/23 21:51

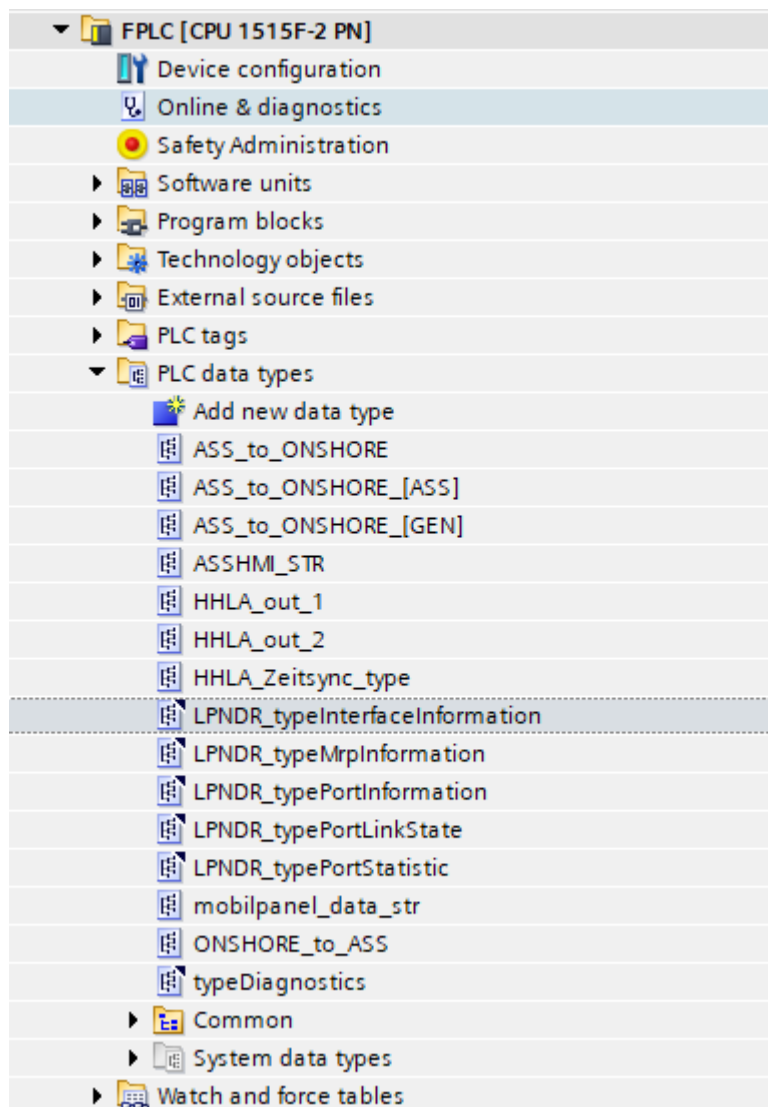

UDT

The structure of the **UDT** (*User Defined Type*) is identical to that of the **STRUCTURE** type; you can create more complex variables from existing variables, structures, and their arrays. The key difference is that while a STRUCTURE is valid within a specific function (FB, FC, OB), a UDT is a universal type that must be defined in a separate library within the TIA Portal (*PLC > PLC data types*). Variables created from the UDT can be used throughout the entire program, which is especially useful for large-scale functions like communication, where maintaining an identical structure is important. However, when modifying a UDT, be aware that it may sometimes cause the program to crash.



Variables created from the UDT can be used throughout the entire program, which is especially useful for large-scale functions like communication, where maintaining an identical structure is important. However, when modifying a UDT, be aware that it may sometimes cause the program to crash.

	Name	Data type	Default value	Accessible f...	Writa...	Visible in ...	Setpoint	Comment
1	macAddress	Array[0..5] of Byte		<input checked="" type="checkbox"/>	<input checked="" type="checkbox"/>	<input checked="" type="checkbox"/>	<input type="checkbox"/>	
2	nameOfStation	String	"	<input checked="" type="checkbox"/>	<input checked="" type="checkbox"/>	<input checked="" type="checkbox"/>	<input type="checkbox"/>	
3	ipAddress	Array[0..3] of USInt		<input checked="" type="checkbox"/>	<input checked="" type="checkbox"/>	<input checked="" type="checkbox"/>	<input type="checkbox"/>	
4	subnetMask	Array[0..3] of USInt		<input checked="" type="checkbox"/>	<input checked="" type="checkbox"/>	<input checked="" type="checkbox"/>	<input type="checkbox"/>	
5	gateway	Array[0..3] of USInt		<input checked="" type="checkbox"/>	<input checked="" type="checkbox"/>	<input checked="" type="checkbox"/>	<input type="checkbox"/>	
6	mrp	*LPNDR_typeMrpInforma...		<input checked="" type="checkbox"/>	<input checked="" type="checkbox"/>	<input checked="" type="checkbox"/>	<input checked="" type="checkbox"/>	

The UDTs shown here fall into two categories: The normal UDTs (icon: ) are fully editable and can be modified freely. The locked UDTs (icon: ) are connected to closed (typically system) functions; modifying them could cause major issues in the program.

A locked UDT is also shown by an icon () in the corner of the editor window.



PLC data types (UDT) can be nested up to 8 levels deep. Starting from firmware V4.0, CPUs in the S7-1500 series support nesting up to 26 levels. Each **ARRAY of STRUCT/UDT** uses 3 hierarchy levels.



The UDT type can be imported and exported quickly. To export: right-click on the specific type, choose "Generate source from blocks," and select "Selected blocks only." To import: go to PLC, then External source files, click "Add new external file," right-click the external file, and select "Generate block from source."

2026/04/23 21:51

OB, DB, FB, FC

PLCs differ from PCs in several ways. Their structure and programming architecture are simpler and more straightforward. A key difference is that they lack a traditional file system; instead, they consist of four main components:

Symbol	Description
	OB - organization block: OBs play a special role in running programs, as they essentially start programs based on various criteria. The simplest is OB1, which runs 'continuously'. As soon as a complete execution cycle ends — that is, all programs started from the OB have run — it restarts them after the signals are output and read. There are scheduled, error-related, and interrupt OBs; more details are available in the OB section .
	A DB - data block: A DB organizes data based on various aspects and has two primary types. The global DB is created directly by the programmer, whereas the instant DB is a storage block assigned to an FB. For more information, refer to the DB chapter .
	FC - FB: Throughout the program, modules that are repeated multiple times or are structurally different can be organized into FBs or FCs. This approach is crucial during commissioning and later corrections to ensure the code remains clear and well-structured. For instance, unorganized code 'dumped' into OB1 raises concerns for experienced programmers reviewing the system. Several other red flags exist, where acceptance only occurs if the code is entirely rewritten.
	FC - Function. These are basic program blocks that do not pass variables to subsequent cycles. Examples include a module that creates colors in an HMI or a segment that performs mathematical operations. Further details are available in the FC chapter .

	<p>FB – function block. Each FB is always linked to a Data Block (DB) that holds some of its data. This DB operates independently of cycles. Sometimes, it isn't a unique DB but a multi-instance DB. More information about these can be found in the FB chapter.</p>
	<p>iDB - instant DB: Although it appears as a standard DB in the TIA Portal without a distinct symbol, I am explicitly identifying this DB type in this document. It is always linked to a specific FB and stores the non-temporary data of that FB. For more information, refer to the DB chapter.</p>

An example of program calls

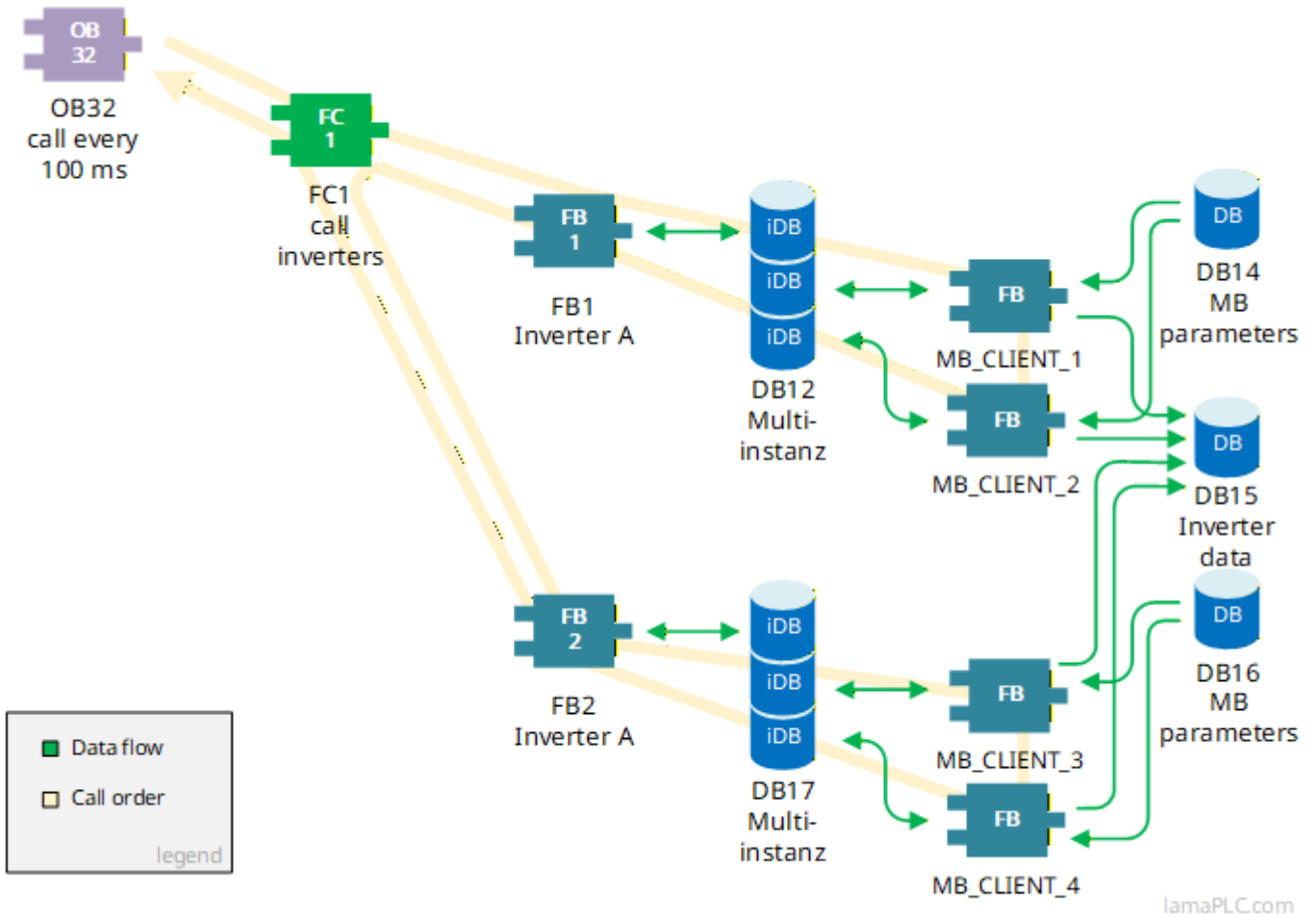

1. The OB32 calls the FC1 cyclically every 100 ms.
2. The FC1 first calls the first inverter, then the second inverter.
3. The FB1, whose instant data block is DB12, is called. The FB1 initiates a Modbus Client call (MB_CLIENT_1), which reads its parameters (IP, unitID, etc.) from DB14. Because this FB is embedded within FB1, it receives a multi-instant block in DB12. The results of the Modbus read are written to DB15.
4. The second Modbus read operates similarly, with its parameters also in DB14 and its multi-instant block in DB12.
5. FC1 is called again, which then calls inverter2, following a similar call sequence as the first case.
6. Control returns to OB32, which waits for the next 100 ms cycle and then calls FC1 again.

2026/04/23 21:51

Data block (DB)

“DB” stands for DATA_BLOCK or the German term “Datenbaustein”, indicating a data area. It can contain various data types permitted and defined by the specific PLC. The total size of all DBs is limited by the PLC's data capacity. Since the PLC isn't optimized for storing large data, we do not save images, music, files, or extensive text files within a DB. In the TIA-Portal, DBs are marked with a small blue barrel icon (). The image below shows the contents of a DB, along with some settings:

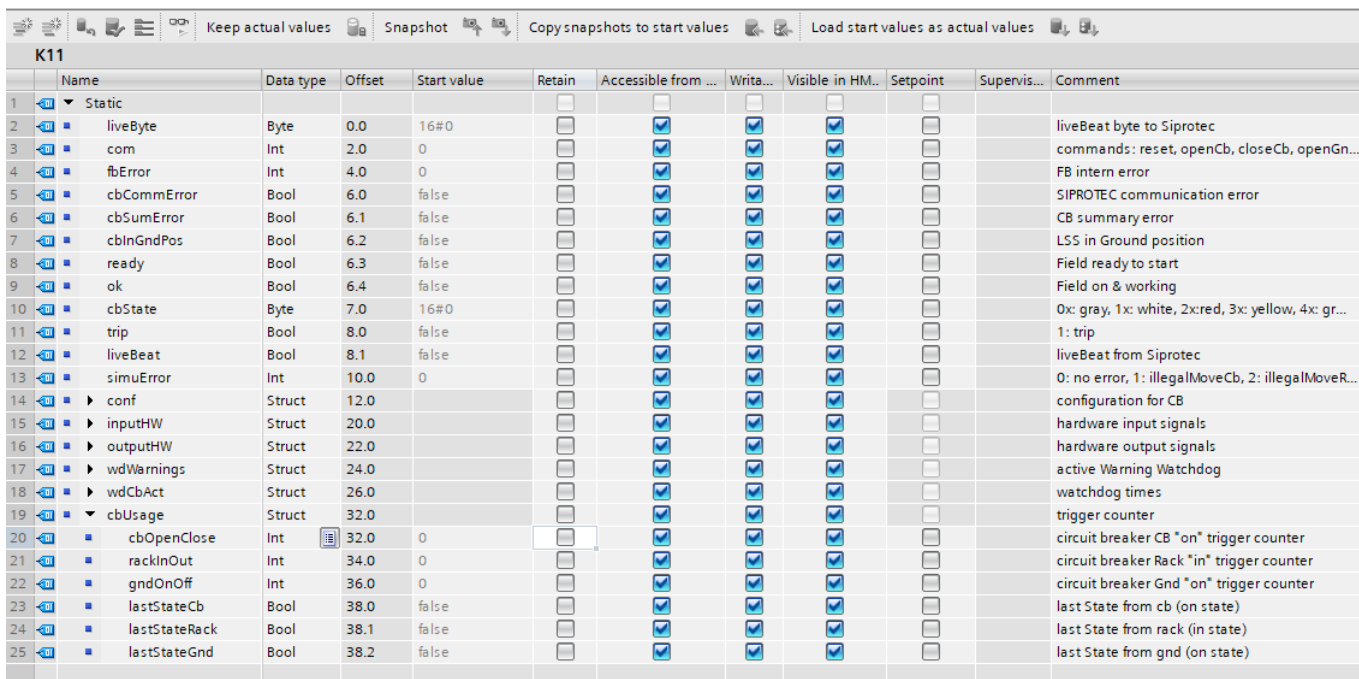

	Name	Data type	Offset	Start value	Retain	Accessible from ...	Writa...	Visible in HM...	Setpoint	Supervis...	Comment
1	Static										
2	liveByte	Byte	0.0	16#0		<input checked="" type="checkbox"/>	<input checked="" type="checkbox"/>	<input checked="" type="checkbox"/>			liveBeat byte to Siprotec
3	com	Int	2.0	0		<input checked="" type="checkbox"/>	<input checked="" type="checkbox"/>	<input checked="" type="checkbox"/>			comands: reset, openCb, closeCb, openGn...
4	fbError	Int	4.0	0		<input checked="" type="checkbox"/>	<input checked="" type="checkbox"/>	<input checked="" type="checkbox"/>			FB intern error
5	cbCommError	Bool	6.0	false		<input checked="" type="checkbox"/>	<input checked="" type="checkbox"/>	<input checked="" type="checkbox"/>			SIPROTEC communication error
6	cbSumError	Bool	6.1	false		<input checked="" type="checkbox"/>	<input checked="" type="checkbox"/>	<input checked="" type="checkbox"/>			CB summary error
7	cbInGndPos	Bool	6.2	false		<input checked="" type="checkbox"/>	<input checked="" type="checkbox"/>	<input checked="" type="checkbox"/>			LSS in Ground position
8	ready	Bool	6.3	false		<input checked="" type="checkbox"/>	<input checked="" type="checkbox"/>	<input checked="" type="checkbox"/>			Field ready to start
9	ok	Bool	6.4	false		<input checked="" type="checkbox"/>	<input checked="" type="checkbox"/>	<input checked="" type="checkbox"/>			Field on & working
10	cbState	Byte	7.0	16#0		<input checked="" type="checkbox"/>	<input checked="" type="checkbox"/>	<input checked="" type="checkbox"/>			0x: gray, 1x: white, 2x:red, 3x: yellow, 4x: gr...
11	trip	Bool	8.0	false		<input checked="" type="checkbox"/>	<input checked="" type="checkbox"/>	<input checked="" type="checkbox"/>			1: trip
12	liveBeat	Bool	8.1	false		<input checked="" type="checkbox"/>	<input checked="" type="checkbox"/>	<input checked="" type="checkbox"/>			liveBeat from Siprotec
13	simuError	Int	10.0	0		<input checked="" type="checkbox"/>	<input checked="" type="checkbox"/>	<input checked="" type="checkbox"/>			0: no error, 1: illegalMoveCb, 2: illegalMoveR...
14	conf	Struct	12.0			<input checked="" type="checkbox"/>	<input checked="" type="checkbox"/>	<input checked="" type="checkbox"/>			configuration for CB
15	inputHW	Struct	20.0			<input checked="" type="checkbox"/>	<input checked="" type="checkbox"/>	<input checked="" type="checkbox"/>			hardware input signals
16	outputHW	Struct	22.0			<input checked="" type="checkbox"/>	<input checked="" type="checkbox"/>	<input checked="" type="checkbox"/>			hardware output signals
17	wdWarnings	Struct	24.0			<input checked="" type="checkbox"/>	<input checked="" type="checkbox"/>	<input checked="" type="checkbox"/>			active Warning Watchdog
18	wdCbAct	Struct	26.0			<input checked="" type="checkbox"/>	<input checked="" type="checkbox"/>	<input checked="" type="checkbox"/>			watchdog times
19	cbUsage	Struct	32.0			<input checked="" type="checkbox"/>	<input checked="" type="checkbox"/>	<input checked="" type="checkbox"/>			trigger counter
20	cbOpenClose	Int	32.0	0		<input checked="" type="checkbox"/>	<input checked="" type="checkbox"/>	<input checked="" type="checkbox"/>			circuit breaker CB "on" trigger counter
21	rackInOut	Int	34.0	0		<input checked="" type="checkbox"/>	<input checked="" type="checkbox"/>	<input checked="" type="checkbox"/>			circuit breaker Rack "in" trigger counter
22	gndOnOff	Int	36.0	0		<input checked="" type="checkbox"/>	<input checked="" type="checkbox"/>	<input checked="" type="checkbox"/>			circuit breaker Gnd "on" trigger counter
23	lastStateCb	Bool	38.0	false		<input checked="" type="checkbox"/>	<input checked="" type="checkbox"/>	<input checked="" type="checkbox"/>			last State from cb (on state)
24	lastStateRack	Bool	38.1	false		<input checked="" type="checkbox"/>	<input checked="" type="checkbox"/>	<input checked="" type="checkbox"/>			last State from rack (in state)
25	lastStateGnd	Bool	38.2	false		<input checked="" type="checkbox"/>	<input checked="" type="checkbox"/>	<input checked="" type="checkbox"/>			last State from gnd (on state)

The columns are as follows:

Column	Description
Name	The name of the variable within the DB. The variable names are unique, and the DB name is displayed in the upper-left corner, in this case: <i>K11</i> . The variable names are supplemented with this, e.g., " <i>K11</i> ". <i>liveByte</i> . This also means that the DB can be copied and renamed one-for-one. That is, if this DB is copied and renamed to, for example, " <i>K12</i> ", the above reference will be " <i>K12</i> ". <i>liveByte</i> . In the case of a structure, for example, " <i>cbUsage</i> ", the entire structure depth must be defined, for example: " <i>K11</i> ". <i>cbUsage.cbOpenClose</i> .
Data type	The data type. Structures and arrays must be created when defining the DB by entering, for example, type Struct in the Data type field.
Offset	The offset of the variable within the DB. This appears only for non-optimized DBs. More details: optimized DB
Start value	The starting value of the given variables, which the PLC takes on when restarting. The default value can be overwritten in the cell.
Retain	Values to be retained when restarting. It can only be set for the entire DB, so it is worth grouping the values to be stored in a DB
Accessible from HMI/OPC UA/Web API	The value is accessible from external applications. For structures and arrays, the setting can only be defined for the entire block. OPC access can be enabled/disabled in the settings, see DB Properties .
Writable from HMI/OPC UA/Web API	The given value can be written from external applications.

Column	Description
Visible in HMI engineering	The setting disables or enables the HMI integration of the variable. In addition to disabling HMI, OPC can also be enabled, see DB Properties .
Setpoint	This allows you to initialize values in a data block (DB) online while the CPU is in RUN mode.
Comment	Description of the function of the field.

DB Limits

- You can define up to 252 structures within a single data block for S7-1200/S7-1500, regardless of the data types used in the structures.
- Maximum DB Number: The total number of data blocks is generally capped at 65,535, due to the common use of a 16-bit address range.
- Maximum DB Size (Standard - not optimized - Access): For older PLC models like S7-300/400 and for standard access DBs in newer models, each DB's size typically does not exceed 64 KB (65,534 bytes).
- Maximum DB Size (Optimized Access): In contrast, S7-1200/S7-1500 CPUs that utilize optimized access have a much larger size limit, which varies based on the CPU's total working memory and can reach from 1 MB up to 10 MB or more per DB.

Instant vs global DB

A **global DB** is a data block that programmers can freely create and populate with variables. These variables may include default Simatic types (INT, REAL, etc.), structures, arrays, or UDTs.

Instant DBs are implicitly created when FBs are called for the first time. This call is primarily through the instant DB. When an FB is deleted, the TIA Portal also issues a separate warning about removing the instant DB. The contents of the instant DB automatically update with changes to the FB's variable list. It can include default Simatic variables like INT, REAL, structures, arrays, and UDTs. If the FB calls other embedded FBs (e.g., TON, TOF), their instant DBs are also stored here, resulting in a **multi-instant DB**.

DB Properties

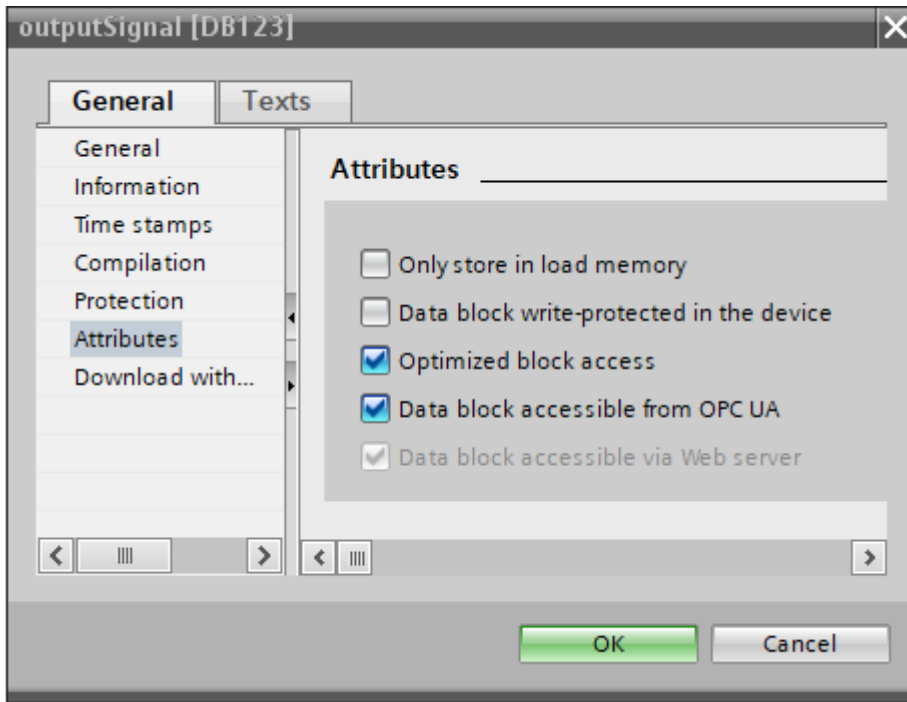

(right-click on the DB → Properties..)

Name the attribut	Description
Only store in load memory	This attribute is stored on the PLC's Micro Memory Card (MMC) or similar non-volatile storage, not in the CPU's working RAM, making it ideal for large, infrequently used data such as recipes or logs. It's accessed using special instructions like READ_DBL or WRIT_DBL to transfer data to/from working memory. This preserves precious working memory, but requires explicit programming to move data for active processing. The data survives power cycles but can be lost with a factory reset.
Data block write-protected in the device	Make the entire data block read-only.
Optimized block access	Optimized variable order within the DB. See below: Optimized DB .
Data block accessible from OPC UA	The data block can be accessed and published by OPC UA. See: OPC UA .

Optimized DB

Simatic groups variables in the optimized DB so they occupy as little storage space as possible. This means that it is “not visible from the outside” where a given data item is located within the storage space, i.e., in this case, the offset is not displayed in the editor window:

Name	Data type	Start value	Retain	Accessible f...	Writa...	Visible in ...	Setpoint	Supervis...	Comment
Static									
relK15_1	Bool	false		<input checked="" type="checkbox"/>	<input checked="" type="checkbox"/>	<input checked="" type="checkbox"/>			release K15 ch 1
relK15_2	Bool	false		<input checked="" type="checkbox"/>	<input checked="" type="checkbox"/>	<input checked="" type="checkbox"/>			release K15 ch 2
relK17_1	Bool	false		<input checked="" type="checkbox"/>	<input checked="" type="checkbox"/>	<input checked="" type="checkbox"/>			release K17 ch 1
relK17_2	Bool	false		<input checked="" type="checkbox"/>	<input checked="" type="checkbox"/>	<input checked="" type="checkbox"/>			release K17 ch 2

On the one hand, this helps better utilize the PLC's storage space. Still, on the other hand, it makes

operations that require direct addressing (communication modules - Modbus, direct addressing, etc.) impossible. In such cases, this option must be disabled in the settings (*right-click on the DB* → *Properties..* → *Attributes* → *Optimized block access* → *OFF*)

Tags vs DB data

There are two basic methods for storing data in PLCs (in a simplified view). One involves placing variables in a global memory table alongside input and output variables, while the other uses data blocks (DBs). From my experience, storing data in DBs tends to be simpler and more straightforward for several reasons.

- Function-specific data can be stored in DBs. For example, the “motor1” DB contains only data for the 1st motor, but all of them (speed, load, temperature, on-off, errors, ...)
- If someone wants to define a “motor2” as well, identical to “motor1” in terms of its parameters, they just need to copy the previous DB
- Cross-reference management of data immediately points to the given DB, from which we can immediately deduce their function
- If the data is already in the instant DBs assigned to the FBs, it is easy to embed them in a calling FB to use them as multi-instants.

Typically, I don't bother defining variables within the Tags; creating them directly in the databases suffices—though this is just my personal preference.

Storing DB records in the load memory

In PLCs, working memory is PLC-dependent and often very limited. We may have a lot of information that does not need to be read and written cyclically. Examples include recipe data (a list of technological components), parameter data, or database assignments that are needed only occasionally.

In these cases, one option is to store the data not in working memory but on the SD card and in load memory, and to transfer them only when needed using the “WRIT_DBL” and “READ_DBL” operations.

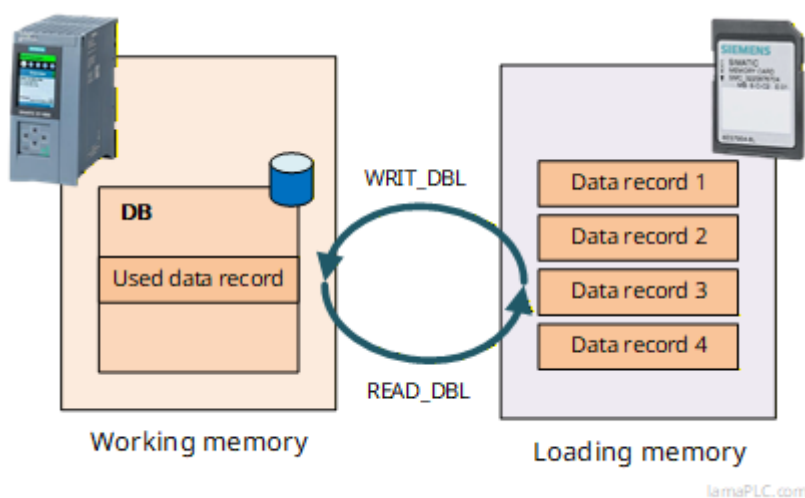



More information:

TIA Datatypes: [S7 data types summary table](#)

2026/04/23 21:51

Direct/indirect addressing

Addressing methods are mostly tied to variable types, not areas, so the following procedures apply to both DB and Tag variables.

Direct addressing

Direct addressing in Simatic is typically symbolic addressing, meaning in the simplest case we correspond two variables of the same type to each other:

```
fromReal : Real;  
fromInt  : Int;  
toReal   : Real;  
toInt    : Int;  
...  
  
#toInt := #fromInt;  
#toReal := #fromReal;
```

If the types do not match, conversion will help us:

```
#toInt := REAL_TO_INT(IN := #fromReal);
```



It is crucial to understand that conversion can lead to data loss. In the example above, the **REAL** type can store much larger numbers and fractional parts, while the **INT** only handles smaller integers and rounds off fractions. When converting between variables with different ranges, all values outside the smaller range should be considered. In this case, rather than using an **INT**, a variable with a broader range should be selected (example **DINT**, **LINT**).

Direct addressing is also applicable to **STRUCTURE** and **ARRAY** types, provided both sides have identical structures.

Another approach is direct addressing, which involves referring to a variable's sub-elements. Although this method applies to a limited range of variables, it is a simple form of assignment. While it isn't as straightforward as the S7-Classic AT command that many programmers prefer, it is at least available:

Slice addressing

Slice addressing involves dividing a memory region, such as a byte or a word, into smaller segments, such as booleans. With S7-1200 and S7-1500, you can target specific parts within declared variables (**only by byte, word, dword**) and access segments of 1, 8, 16, or 32 bits.

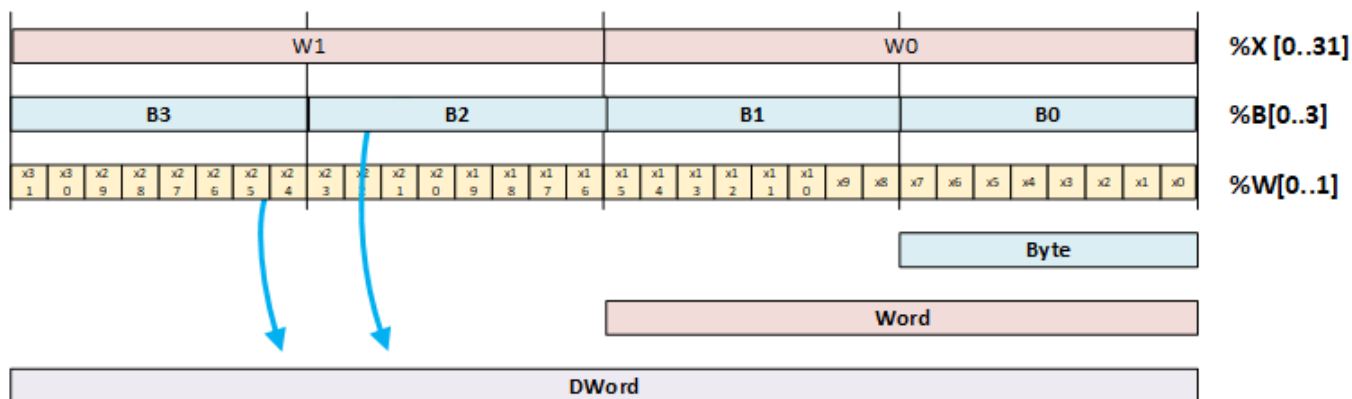

Examples:

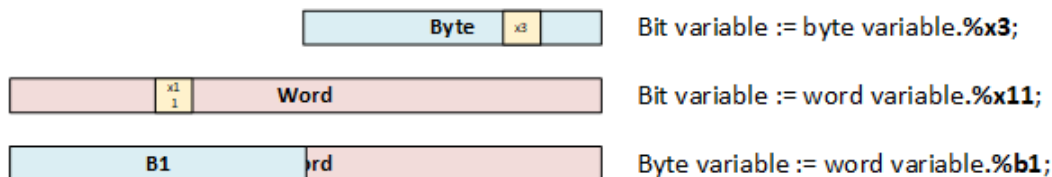

The following example is a SPLIT function that splits a WORD Input variable into bits:

```
// FC Input : inWord (Word)
// FC output: 16 variable bit0..bit15 (Bool)
// splitting
#bit0 := #inWord.%X0;
#bit1 := #inWord.%X1;
#bit2 := #inWord.%X2;
#bit3 := #inWord.%X3;
#bit4 := #inWord.%X4;
#bit5 := #inWord.%X5;
#bit6 := #inWord.%X6;
#bit7 := #inWord.%X7;
#bit8 := #inWord.%X8;
#bit9 := #inWord.%X9;
#bitA := #inWord.%X10;
#bitB := #inWord.%X11;
#bitC := #inWord.%X12;
#bitD := #inWord.%X13;
#bitE := #inWord.%X14;
#bitF := #inWord.%X15;
```

Pointer; indirect addressing

In the TIA Portal, there are two ways to perform indirect addressing or pointer referencing: the **ANY** and the **VARIANT**. However, it is important to note that the S7-1200 series PLCs do not support the ANY method. Using a pointer essentially involves moving a data block of a specific size to a memory area of the same size. This operation ignores the structure and variables within the data area, making it a quick and useful method when applied carefully. **However, careless use of this tool can be very risky.**

A key issue is that it doesn't handle the variables within the data being pointed to; for example, when searching for errors with xref, these procedures are not visible to the compiler, which can lead to difficult-to-detect errors caused by improper pointer use.

ANY type

Structure of the ANY Pointer (**10 Bytes**):

Name	Length	Description
Syntax ID	1 byte	Always 16#10 for S7
Data Type	1 byte	Code for the type of data being pointed to (e.g., 16#02 for Byte; see below in the table "TIA Coding of data types")
Repetition Factor	2 bytes	Number of elements of the specified data type
DB Numbe	2 bytes	The number of the data block (0 if not in a DB)
Memory Area	1 byte	Code for the memory area (e.g., 16#84 for DB; see below in the table "TIA Coding of the memory area")
Address	3 bytes	The start address of the data (bit and byte address)

TIA Coding of data types

The following table lists the coding of data types for the **ANY** pointer:

Hexadecimal code	Data type	Description
B#16#00	NIL	Null pointer
B#16#01	BOOL	Bits
B#16#02	BYTE	bytes, 8 bits
B#16#03	CHAR	8-bit characters
B#16#04	WORD	16-bit words
B#16#05	INT	16-bit integers
B#16#06	DWORD	32-bit words
B#16#07	DINT	32-bit integers
B#16#08	REAL	32-bit floating-point numbers
B#16#0B	TIME	Time duration
B#16#0C	S5TIME	Time duration
B#16#09	DATE	Date
B#16#0A	TOD	Date and time
B#16#0E	DT	Date and time
B#16#13	STRING	Character string
B#16#17	BLOCK_FB	Function block

Hexadecimal code	Data type	Description
B#16#18	BLOCK_FC	Function
B#16#19	BLOCK_DB	Data block
B#16#1A	BLOCK_SDB	System data block
B#16#1C	COUNTER	Counter
B#16#1D	TIMER	Timer

2026/04/23 21:51

TIA Coding of the memory area

The following table lists the coding of the memory areas for the **ANY** pointer:

Hexadecimal code	Area	Description
B#16#80	P	I/O
B#16#81	I	Memory area of inputs
B#16#82	Q	Memory area of outputs
B#16#83	M	Memory area of bit memory
B#16#84	DBX	Data block
B#16#85	DIX	Instance data block
B#16#86	L	Local data
B#16#87	V	Previous local data

2026/01/16 14:16

Example of using the ANY type

The pointer with the ANY type is most frequently used with the **BLKMOV** command, which copies data from one area to another indirectly. In the example below, the created dataset is transferred to one of three mobile data areas based on the location of the variable `"assHMI".Panel1ASS` points:

```

CASE "assHMI".Panel1ASS OF
  1: // ASS1 data to disp 1
    #state := BLKMOV(SRCBLK := P#db108.dbx0.0 BYTE 72, DSTBLK =>
P#db108.dbx216.0 BYTE 72);
  2: // ASS1 data to disp 2
    #state := BLKMOV(SRCBLK := P#db108.dbx72.0 BYTE 72, DSTBLK =>
P#db108.dbx216.0 BYTE 72);
  3: // ASS1 data to disp 3
    #state := BLKMOV(SRCBLK := P#db108.dbx144.0 BYTE 72, DSTBLK =>
P#db108.dbx216.0 BYTE 72);
  ELSE // Statement section ELSE
    ;
END_CASE;

```

VARIANT versus ANY

- **ANY** is a fixed 10-byte structure that references an absolute memory address.

- **VARIANT** is a type-safe pointer that preserves the original data type information and enables symbolic addressing without the need for fixed memory location overhead.
- The **ANY** is an older type, already available in the S300 / 400 series.

* The **ANY** can only be used with the S7-1500, whereas **VARIANT** are accessible on all S7 models.

VARIANT type

A VARIANT type parameter is a pointer that can reference various data types beyond a simple instance. This pointer can be an object of a basic data type like **INT** or **REAL**, or it can be a **STRING**, **DTL**, **ARRAY of STRUCT**, **UDT**, or an **ARRAY of UDT**. The VARIANT pointer can also recognize structures and point directly to individual members of those structures. An operand of VARIANT type does not consume space in the instance data block or work memory but does require memory on the CPU.



- Directly assigning a tag to a VARIANT, like *myVARIANT := #Variable*, is not possible.
- Direct reading or writing of a signal from an I/O input or output is only possible with an S7-1500 module.
- You can only reference a complete data block if it was originally created from a user-defined data type (**UDT**).

2026/01/16 18:24



If you'd like to support the development of the site with the price of a coffee — or a few — [please do so here](#).

2026/01/06 16:16

TIA Data type limits

Decimal	Hex	TIA data type	Byte	Description
18,446,744,073,709,551,615	FFFF FFFF FFFF FFFF	LWORD , ULINT	8	The maximum unsigned 64 bit value ($2^{64} - 1$)
9,223,372,036,854,775,807	7FFF FFFF FFFF FFFF	LINT	8	The maximum signed 64 bit value ($2^{63} - 1$)
9,007,199,254,740,992	0020 0000 0000 0000	-	8	The largest consecutive integer in IEEE 754 double precision (2^{53})
4,294,967,295	FFFF FFFF	DWORD , UDINT	4	The maximum unsigned 32 bit value ($2^{32} - 1$)
2,147,483,647	7FFF FFFF	DINT	4	The maximum signed 32 bit value ($2^{31} - 1$)

Decimal	Hex	TIA data type	Byte	Description
16,777,216	0100 0000	-	4	The largest consecutive integer in IEEE 754 single precision (2 ²⁴)
65,535	FFFF	WORD, UINT	2	The maximum unsigned 16 bit value (2 ¹⁶ - 1)
32,767	7FFF	INT	2	The maximum signed 16 bit value (2 ¹⁵ - 1)
255	FF	BYTE	1	The maximum unsigned 8 bit value (2 ⁸ - 1)
127	7F	SINT	1	The maximum signed 8 bit value (2 ⁷ - 1)
-128	80	SINT	2	Minimum signed 8 bit value
-32,768	8000	INT	2	Minimum signed 16 bit value
-2,147,483,648	8000 0000	DINT	4	Minimum signed 32 bit value
-9,223,372,036,854,775,808	8000 0000 0000 0000	LINT	8	Minimum signed 64 bit value

2026/04/23 21:51

TIA Datatypes

List of data types used by Simatic S7. The page contains the more modern TIA variable types as well as the earlier S7-classic types.



There are four data types in: Boolean, Text, Numeric, and Date/Time. Each data type defines the format of information that can be entered into a data field and stored in your database.

Datotyp	Width (bits)	Range of values	Examples	S7-300/400	S7-1200	S7-1500
Binaries						
BOOL (x) →details	1 (S7-1500 optimized 1 Byte)	FALSE or TRUE BOOL#0 or BOOL#1 BOOL#FALSE oder BOOL#TRUE	TRUE BOOL#1 BOOL#TRUE	X	X	X
BYTE (b) →details	8	B#16#00 .. B#16#FF 0 .. 255 2#0 .. 2#11111111	15, BYTE#15, B#15	X	X	X
WORD (w) →details	16	W#16#0000 .. W#16#FFFF 0 .. 65.535 B#(0, 0) .. B#(255, 255)	55555, WORD#55555, W#555555	X	X	X
DWORD (dw) →details	32	DW#16#0000 0000 .. DW#16#FFFF FFFF 0 .. 4,294,967,295	DW#16#DEAD BEEF B#(111, 222, 255, 200)	X	X	X
LWORD (lw) →details	64	LW#16#0000 0000 0000 0000 .. LW#16#FFFF FFFF FFFF FFFF 0 .. 18.446.744.073.709.551.615	LW#16#DEAD BEEF DEAD BEEF B#(111, 222, 255, 200, 111, 222, 255, 200)	-	-	X
Datotyp						
Datotyp	Width (bits)	Range of values	Examples	S7-300/400	S7-1200	S7-1500
Integers						
SINT (si) →details	8	-128 .. 127 (hex only positive) 16#0 .. 16#7F	+42, SINT#+42 16#1A, SINT#16#2A	-	X	X
INT (i) →details	16	-32.768 .. 32.767 (hex only positive) 16#0 .. 16#7FFF	+1234, INT#+3221 16#1ABC	X	X	X
DINT (di) →details	32	-2.147.483.648 .. +2.147.483.647 (hex only positive) 16#00000000 .. 16#7FFFFFFF	123456, DINT#123.456, 16#1ABC BEEF	X	X	X
USINT (usi) →details	8	0 .. 255 16#00 .. 16#FF	42, USINT#42 16#FF	-	X	X
UINT (ui) →details	16	0 .. 65.535 16#0000 .. 16#FFFF	12.345, UINT#12345 16#BEEF	-	X	X

Datotyp	Width (bits)	Range of values	Examples	S7-300/400	S7-1200	S7-1500
UDINT (udi) →details	32	0 .. 4.294.967.295 16#00000000 .. 16#FFFF FFFF	1.234.567.890, UDINT#1234567890	-	X	X
LINT (li) →details	64	-9.223.372.036.854.775.808 .. +9.223.372.036.854.775.807	+1.234.567.890.123.456.789, LINT#+1.234.567.890.123.456.789	-	-	X
ULINT (uli) →details	64	0 .. 18.446.744.073.709.551.615	123.456.789.012.345, ULINT#123.456.789.012.345	-	-	X
Datotyp	Width (bits)	Range of values	Examples	S7-300/400	S7-1200	S7-1500
floating point numbers						
REAL ® →details	32	-3.402823e+38 .. -1.175 495e-38 .. +1.175 495e-38 .. +3.402823e+38	0.0, REAL#0.0 1.0e-13, REAL#1.0e-13	X	X	X
LREAL (lr) →details	64	-1.7976931348623158e+308 .. -2.2250738585072014e-308 .. +2.2250738585072014e-308 .. +1.7976931348623158e+308	0.0, LREAL#0.0	-	X	X
Datotyp	Width (bits)	Range of values	Examples	S7-300/400	S7-1200	S7-1500
Times						
S5TIME (s5t) →details	16	S5T#0H_0M_0S_0MS .. S5T#2H_46M_30S_0MS	S5T#10s, S5TIME#10s	X	-	X
TIME (t) →details	32	T#-24d20h31m23s648ms .. T#+24d20h31m23s647ms	T#13d14h15m16s630ms, TIME#1d2h3m4s5ms	X	X	X
LTIME (lt) →details	64	LT#-106751d23h47m16s854ms775us808ns .. LT#+106751d23h47m16s854ms775us807ns	LT#1000d10h15m24s130ms152us15ns, LTIME#200d2h2m1s8ms652us315ns	-	-	X
Timer operations: IEC timers, TON (Generate on-delay), TOF (Generate off-delay), TP (Generate pulse), TONR (Time accumulator)						
Datotyp	Width (bits)	Range of values	Examples	S7-300/400	S7-1200	S7-1500
Counters						
CHAR →details	8	ASCII character set	'A', CHAR#'A'	X	X	X
WCHAR (wc) →details	16	Unicode character set	WCHAR#'A'	-	X	X
STRING (s) →details	n+2 (Byte)	0 .. 254 characters (n)	'Name', STRING#'lamaPLC'	X	X	X
WSTRING (ws) →details	n+2 (Word)	0 .. 16382 characters (n)	WSTRING#'lamaPLC'	-	X	X
Counter operations: CTU (count up), CTD (count down), CTUD (count up and down)						
Datotyp	Width (bits)	Range of values	Examples	S7-300/400	S7-1200	S7-1500
Date & time						
DATE (d) →details	16	D#1990-01-01 .. D#2168-12-31	D#2020-08-14, DATE#2020-08-14	X	X	X
TOD (tod) (TIME_OF_DAY) →details	32	TOD#00:00:00.0000 .. TOD#23:59:59.999	TOD#11:22:33.444, TIME_OF_DAY#11:22:33.444	X	X	X
LTOD (ltod) (LTIME_OF_DAY) →details	64	LTOD#00:00:00.000000000 .. LTOD#23:59:59.999999999	LTOD#11:22:33.444_555_111, LTIME_OF_DAY#11:22:33.444_555_111	-	-	X
DT (dt) (DATE_AND_TIME) →details	64	Min.: DT#1990-01-01-0:0:0 Max.: DT#2089-12-31-23:59:59.999	DT#2020-08-14-2:44:33.111, DATE_AND_TIME#2020-08-14-11:22:33.444	X	-	X
LDT (ldt) (L_DATE_AND_TIME) →details	64	Min.: LDT#1970-01-01-0:0:0.000000000, 16#0 Max.: LDT#2262-04-11-23:47:16.854775807, 16#7FFF_FFFF_FFFF_FFFF	LDT#2020-08-14-1:2:3.4	-	-	X
DTL (dtl) →details	96	Min.: DTL#1970-01-01-00:00:00.0 Max.: DTL#2554-12-31-23:59:59.999999999	DTL#2020-08-14-10:12:13.23	-	X	X
Datotyp	Width (bits)	Range of values	Examples	S7-300/400	S7-1200	S7-1500
Pointers						
POINTER (p) →details	48		Symbolic: "DB"."Tag" Absolute: P#10.0 P#DB4.DBX3.2	X	-	X
ANY (any) →details	80		Symbolic: "DB".StructVariable.firstComponent Absolute: P#DB11.DBX12.0 INT 3 P#M20.0 BYTE 10	X	-	X

Datotyp	Width (bits)	Range of values	Examples	S7-300/400	S7-1200	S7-1500
VARIANT (var) →details	0		Symbolic: "Data_TIA_Portal". StructVariable.firstComponent Absolute: %MW10 P#DB10.DBX10.0 INT 12	-	X	X
BLOCK_FB	0		-	X	-	X
BLOCK_FC	0		-	X	-	X
BLOCK_DB	0		-	X	-	-
BLOCK_SDB	0		-	X	-	-
VOID	0		-	X	X	X
PLC_DATA_TYPE	0		-	X	X	X

2026/04/23 21:51

TIA Coding of data types

The following table lists the coding of data types for the [ANY](#) pointer:

Hexadecimal code	Data type	Description
B#16#00	NIL	Null pointer
B#16#01	BOOL	Bits
B#16#02	BYTE	bytes, 8 bits
B#16#03	CHAR	8-bit characters
B#16#04	WORD	16-bit words
B#16#05	INT	16-bit integers
B#16#06	DWORD	32-bit words
B#16#07	DINT	32-bit integers
B#16#08	REAL	32-bit floating-point numbers
B#16#0B	TIME	Time duration
B#16#0C	S5TIME	Time duration
B#16#09	DATE	Date
B#16#0A	TOD	Date and time
B#16#0E	DT	Date and time
B#16#13	STRING	Character string
B#16#17	BLOCK_FB	Function block
B#16#18	BLOCK_FC	Function
B#16#19	BLOCK_DB	Data block
B#16#1A	BLOCK_SDB	System data block
B#16#1C	COUNTER	Counter
B#16#1D	TIMER	Timer

2026/04/23 21:51

From:

<https://www.lamaplc.com/> - lamaPLC

Permanent link:

https://www.lamaplc.com/doku.php?id=automation:s7_var
Last update: **2026/04/21 20:48**